

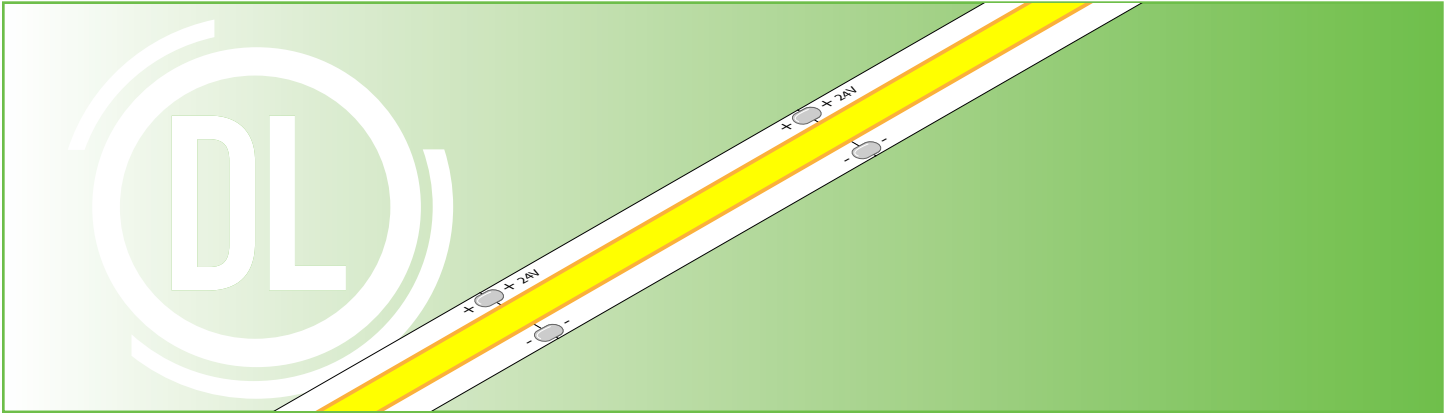

Item # _____

Project _____



SPECIFICATIONS

DI-24V-		STMLT
Voltage		24VDC
Wattage		3.3W/ft.
Lumens¹	2700K	288/ft.
	3000K	292/ft.
	4000K	323/ft.
Max. Run²		16.4 feet
Cut Points		2.5 in
CRI		90+
Dimmable		Yes
Field Cuttable		Yes
Dimensions		0.31 x 0.13 in. (W x H)
Environment*		Indoor / Damp Location
Certification		UL Listed
Warranty		5-Year Warranty

***WARNING: NOT FOR USE IN SUBMERSIBLE APPLICATIONS**

STREAMLITE™ DIFFUSED COB LINEAR LIGHT

SPECIFICATION SHEET

CUSTOM LENGTH TAPE

SKU Builder



DI

-

24V

-

STMLT

-

-

Voltage Model Color Temp Length

COLOR TEMP	LENGTH
27	CSTM (in.)
30	016
40	

Example: DI-24V-STMLT-30-016 = Diode LED, 24 Volt, STREAMLITE™, 3,000° CCT, 16.4 foot spool.

NOTE: All custom cut Tape Lights include 96" lead wires.

MECHANICAL DIAGRAM

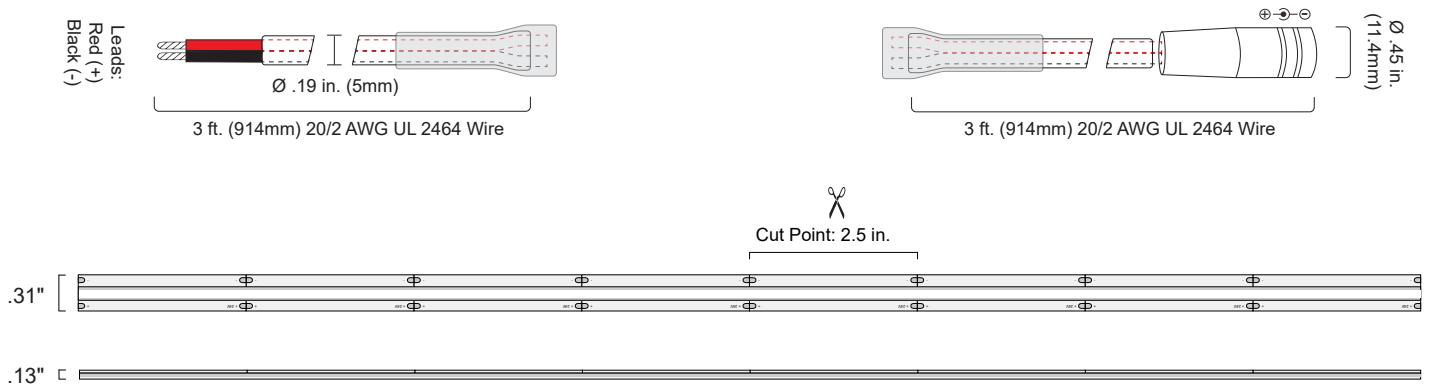

1. Lumen value measured in accordance to IES LM-80-08. LED chips have a luminous flux range with a tolerance of +/- 5%.
2. Each maximum run requires a dedicated power feed from the driver. Do not extend beyond the recommended maximum run length. Max run may exceed Class 2 limit. Actual wattage may differ from calculated wattage due to voltage drop across run.
3. Actual efficacy value is dependent to specified LED driver (power supply). An estimated efficacy value can be calculated as follows: Lumen value divided by average power consumption per foot.
4. Do not install product in an environment outside the listed ambient temperature. Exceeding the maximum ambient temperature may damage LED chips, reduce the total lamp life, lumen output, and/or adversely impact color consistency.
5. Operating temperature is measured according to the minimum and maximum ambient temperature environment.

STREAMLITE™ DIFFUSED COB LINEAR LIGHT

SPECIFICATION SHEET

CHROMAPATH BUILDER CHANNELS

NOTE: Chromapath Builder channel covers are sold separately.

CHROMAPATH® BUILDER SLIM (SL)

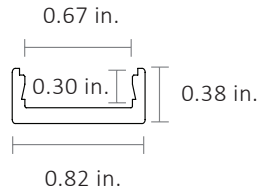

CHANNEL ONLY SKU	FINISH	LENGTH	PRODUCT INCLUDES
DI-CPCHA-SL48**	AL	48 in.	Mounting Clips sold separately.
DI-CPCHA-SL48W**	WH		
DI-CPCHA-SL48B**	BL		
DI-CPCHA-SL96**	AL	96 in.	
DI-CPCHA-SL96W**	WH		
DI-CPCHA-SL96B**	BL		

CHROMAPATH® BUILDER 45° (45)

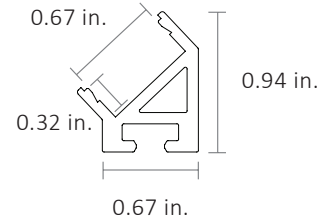
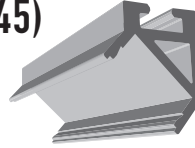

CHANNEL ONLY SKU	FINISH	LENGTH	PRODUCT INCLUDES
DI-CPCHA-4548**	AL	48 in.	4 Mounting Clips with screws and 2 End-to-End Interconnects.
DI-CPCHA-4548W**	WH		
DI-CPCHA-4548B**	BL		
DI-CPCHA-4596**	AL	96 in.	8 Mounting Clips with screws and 4 End-to-End Interconnects.
DI-CPCHA-4596W**	WH		
DI-CPCHA-4596B**	BL		

** - SKUs listed above are for Single Channels only. Add a -10 for a 10 pack bundle (10 pack will include 10x the amount included accessories)

CHROMAPATH® BUILDER SQUARE (SQ)

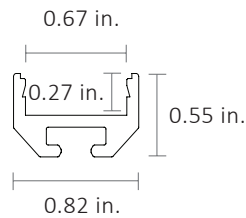
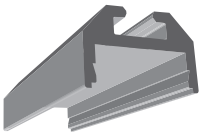

CHANNEL ONLY SKU	FINISH	LENGTH	PRODUCT INCLUDES
DI-CPCHA-SQ48**	AL	48 in.	4 Mounting Clips with screws and 2 End-to-End Interconnects.
DI-CPCHA-SQ48W**	WH		
DI-CPCHA-SQ48B**	BL		
DI-CPCHA-SQ96**	AL	96 in.	8 Mounting Clips with screws and 4 End-to-End Interconnects.
DI-CPCHA-SQ96W**	WH		
DI-CPCHA-SQ96B**	BL		

CHROMAPATH® BUILDER DUO

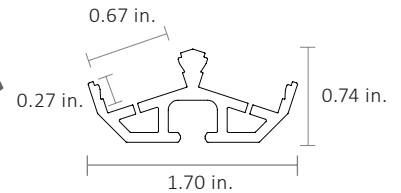
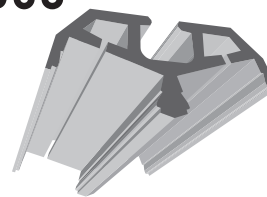

SKU	FINISH	LENGTH	PRODUCT INCLUDES
DI-CPCHA-DU48**	AL	48 in.	4 Mounting Clips
DI-CPCHA-DU48W**	WH		
DI-CPCHA-DU48B**	BL		

** - SKUs listed above are for Single Channels. Add a -10 for a 10 pack bundle (10 pack will include 10x the amount included accessories)

STREAMLITE™ DIFFUSED COB LINEAR LIGHT

SPECIFICATION SHEET

CHROMAPATH BUNDLE CHANNELS

NOTE: CHROMAPATH Bundles are not interchangeable with each other nor compatible with CHROMAPATH Builder channels.

CHROMAPATH® BUNDLE SLIM RECESSED (SLR)

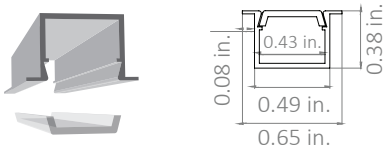

CHANNEL ONLY SKU

PRODUCT INCLUDES

DI-CPCHA-SLR48
DI-CPCHA-SLR96

- 48 and 96 in. channel & frosted cover
- End caps: 1x open square, 1x open round, 1x closed square.

CHROMAPATH® BUNDLE RECESSED (REC)

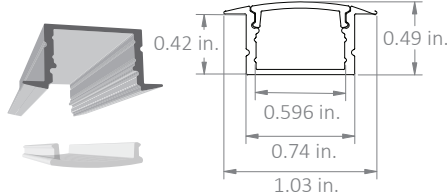

CHANNEL ONLY SKU

PRODUCT INCLUDES

DI-CPCHB-REC-48
DI-CPCHB-REC-96

- 48 and 96 in. channel & frosted cover
- End caps: 1x open, 1x closed
- Mounting hardware

CHROMAPATH® BUNDLE 45° DECO (45DC)

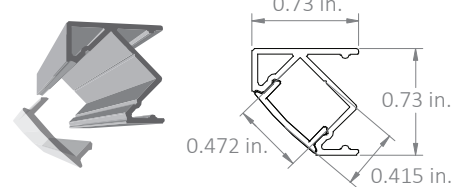

CHANNEL ONLY SKU

PRODUCT INCLUDES

DI-CPCHB-45DCO-48
DI-CPCHB-45DCO-96

- 48 & 96 in. channel & frosted cover
- End caps: 1x open, 1x closed
- Mounting hardware

CHROMAPATH® BUNDLE REFLECTOR (RFC)

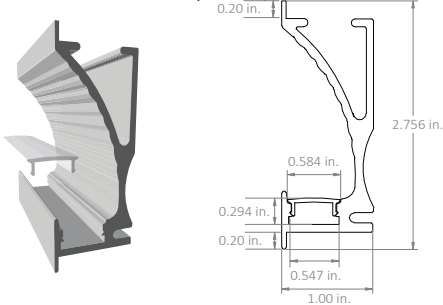

CHANNEL ONLY SKU

PRODUCT INCLUDES

DI-CPCHB-RFCTR-48
DI-CPCHB-RFCTR-96

- 48 and 96 in. channel & frosted cover
- End caps: 1x open, 1x closed

CHROMAPATH® BUNDLE SCENCE (SCNC)

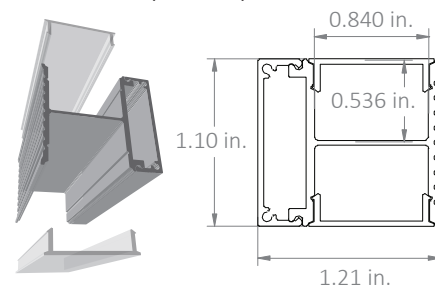

CHANNEL ONLY SKU

PRODUCT INCLUDES

DI-CPCHB-SCNC-48
DI-CPCHB-SCNC-96

- 48 and 96 in. channel, 48 in. mounting plate, 2x frosted covers
- End caps: 1x open, 1x closed

CHROMAPATH® BUNDLE 90° SIDEVIEW (90DC)

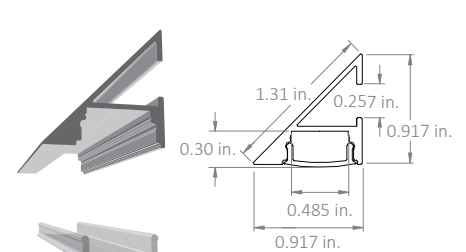

CHANNEL ONLY SKU

PRODUCT INCLUDES

DI-CPCHB-REC-48
DI-CPCHB-REC-96

- 48 and 96 in. channel & frosted cover
- End-caps: 1x open, 1x closed
- Mounting hardware

CHROMAPATH® BUNDLE WAVEFORM (WF)

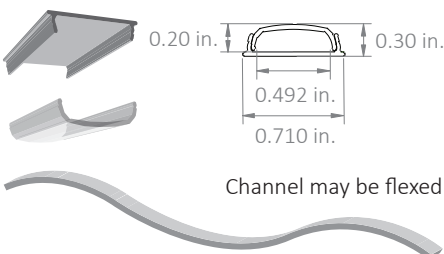

CHANNEL ONLY SKU

PRODUCT INCLUDES

DI-CPCHB-WF-48
DI-CPCHB-WF-96

- 48 and 96 in. channel & frosted cover
- End caps: 1x open, 1x closed
- 2x mounting clip

CHROMAPATH® BUNDLE 10mm SQUARE CORNER (SQ10)

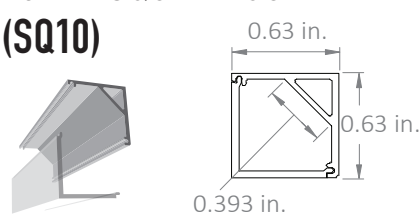

CHANNEL ONLY SKU

PRODUCT INCLUDES

DI-CPCHB-SQC10-48
DI-CPCHB-SQC10-96

- 48 and 96 in. channel & frosted cover
- End-caps: 1x open, 1x closed
- Mounting hardware

CHROMAPATH® BUNDLE 10mm ROUNDED CORNER (RC10)

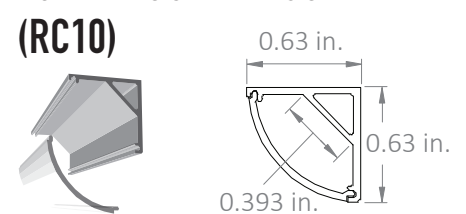

CHANNEL ONLY SKU

PRODUCT INCLUDES

DI-CPCHB-RC10-48
DI-CPCHB-RC10-96

- 48 and 96 in. channel & frosted cover
- End-caps: 1x open, 1x closed
- Mounting hardware

STREAMLITE™ DIFFUSED COB LINEAR LIGHT

SPECIFICATION SHEET

CHROMAPATH BUNDLE CHANNELS (CONT.)

CHROMAPATH® BUNDLE DOME (DME)

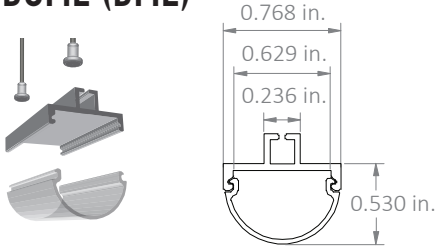

CHANNEL ONLY SKU

DI-CPCHB-DOME-48
DI-CPCHB-DOME-96

PRODUCT INCLUDES

- 48 and 96 in. channel & frosted cover
- End caps: 1x open, 1x closed
- 2x pendant hardware

CHROMAPATH® BUNDLE 20mm SQUARE CORNER (SQ20)

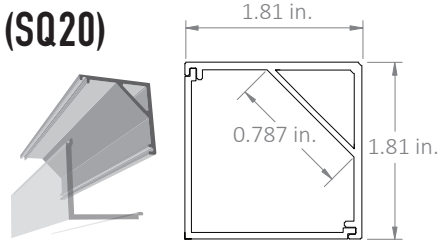

CHANNEL ONLY SKU

DI-CPCHB-SQC20-48
DI-CPCHB-SQC20-96

PRODUCT INCLUDES

- 48 and 96 in. channel & frosted cover
- End-caps: 1x open, 1x closed
- Mounting hardware

CHROMAPATH® BUNDLE 20mm ROUNDED CORNER (RC20)

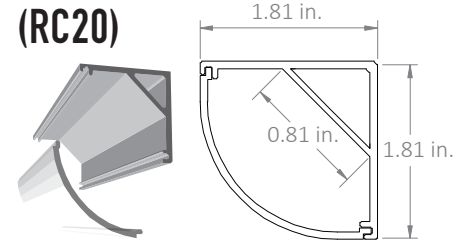

CHANNEL ONLY SKU

DI-CPCHB-RC20-48
DI-CPCHB-RC20-96

PRODUCT INCLUDES

- 48 and 96 in. channel & frosted cover
- End-caps: 1x open, 1x closed
- Mounting hardware

CHROMAPATH® BUNDLE CANAL (CA)

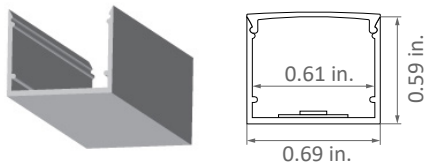

CHANNEL ONLY SKU

DI-CPCHB-CAN48

DI-CPCHB-CAN96

PRODUCT INCLUDES

- 48 and 96 in. channel & opal cover
- End caps: 1x open, 1x closed
- 2x mounting clip
- 96 in. channel & opal cover
- End caps: 2x open, 2x closed
- 4x mounting clip

CHROMAPATH® BUNDLE GRAZER NARROW BEAM (GRZNB)

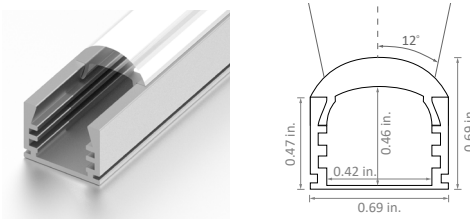

CHANNEL ONLY SKU

DI-CPCHB-GZRN-48

DI-CPCHB-GZRN-96

PRODUCT INCLUDES

- 48 in. channel & clear matte optic lens
- End caps: 48 in. 1x open, 1x closed
- 2x mounting clip
- 96 in. channel & clear matte optic lens
- End caps: 2x open, 2x closed
- 4x mounting clips

STREAMLITE™ DIFFUSED COB LINEAR LIGHT

SPECIFICATION SHEET

COMPATIBLE PRODUCTS

The following Listed LED Drivers are recommended for compatibility and to meet NEC code when installed according to specifications. For additional LED Driver options see Diode LED's product page at: <https://www.diodeled.com/products/led-power-supplies.html>

STAND ALONE

SWITCHEX® DRIVER + DIMMER SWITCH

SWITCHEX combines an LED driver and LED dimmer switch into a single integrated unit. Fits into standard switch boxes.

[SPEC SHEET](#)

	Voltage Output		Power Output
DI	24V	SE	60W

SKU	L - LENGTH	W - WIDTH	H - HEIGHT
DI-24V-SE-60W	1.40 in.	2.10 in.	4.10 in.
DI-24V-SE-100W	1.40 in.	2.10 in.	4.10 in.

Fits in Standard Switch Box

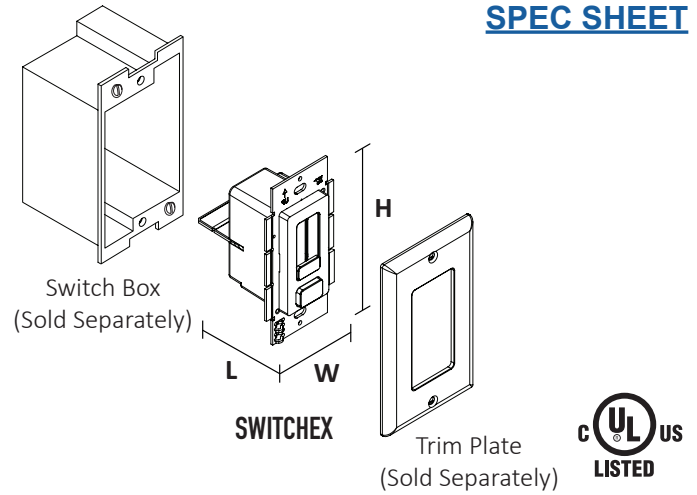

ON/OFF, DMX, & PWM CONTROL

LO-PRO® JUNCTION BOX & DRIVER COMBO - 24V CONSTANT VOLTAGE LED DRIVER

Use Constant Voltage Drivers to power your lighting system. Compatible with Standard 120VAC On/Off Switches, REIGN® Low Voltage Dimmers, TOUCHDIAL™ Control System, DMX Decoders, and PWM Controls.

[SPEC SHEET](#)

	Voltage & Power Output	Junction Box
DI	0970	LPS

SKU	L - LENGTH	W - WIDTH	H - HEIGHT
DI-0970-LPS	11.25 in.	3.75 in.	1.90 in.
DI-CV-MW24V60W-277-LPS	11.25 in.	3.75 in.	1.90 in.
DI-CV-MW24V90W-277-LPS	11.25 in.	3.75 in.	1.90 in.
DI-0954-LPL	13.5 in.	4.5 in.	2.37 in.

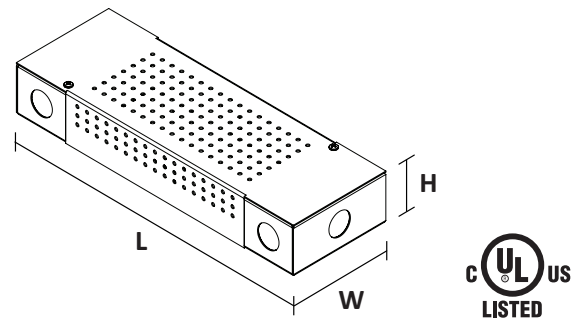

STREAMLITE™ DIFFUSED COB LINEAR LIGHT

SPECIFICATION SHEET

COMPATIBLE PRODUCTS

The following Listed LED Drivers are recommended for compatibility and to meet NEC code when installed according to specifications. For additional LED Driver options see Diode LED's product page at: <https://www.diodeled.com/products/led-power-supplies.html>

0-10V

LO-PRO® JUNCTION BOX & DRIVER COMBO - 24V COMMERCIAL GRADE 0-10V LED DIMMABLE DRIVER

Compatible with 0-10V controls and dimming systems.

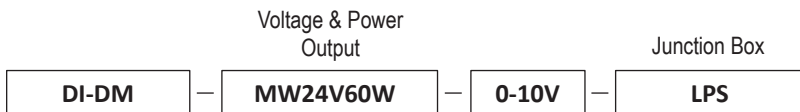

SKU	L - LENGTH	W - WIDTH	H - HEIGHT
DI-DM-MW24V60W-0-10V-LPS	11.25 in.	3.75 in.	1.90 in.
DI-DM-MW24V90W-0-10V-LPL	13.5 in.	4.5 in.	2.37 in.

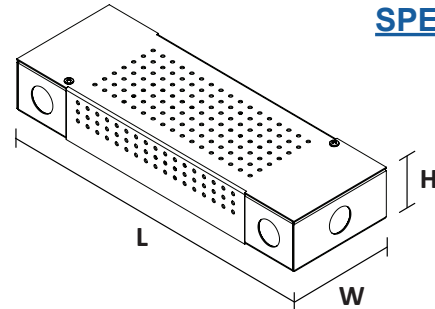

[SPEC SHEET](#)



ELECTRONIC DRIVERS

OMNIDRIVE® 24V ELECTRONIC DIMMABLE LED DRIVER

Compatible with Forward Phase and Reverse Phase Dimmers. Please see Diode LED's Compatibility List at: <https://www.diodeled.com/custom/download/productFile/filename/DI-OD2-Compatibility%20List.pdf/>



SKU	L - LENGTH	W - WIDTH	H - HEIGHT
DI-TD-24V-10W	a 5.5 in.	1.8 in.	1.1 in.
DI-TD-24V-20W	a 5.5 in.	1.8 in.	1.1 in.
DI-TD-24V-30W	a 7 in.	2.3 in.	1.4 in.
DI-TD-24V-45W	a 7 in.	2.3 in.	1.4 in.
DI-TD-24V-60W	b 7.9 in.	2.7 in.	1.8 in.
DI-TD-24V-80W	b 7.9 in.	2.7 in.	1.8 in.
DI-TD-24V-120W	b 9.1 in.	2.7 in.	1.8 in.

[INDOOR SPEC SHEET](#)
[OUTDOOR SPEC SHEET](#)

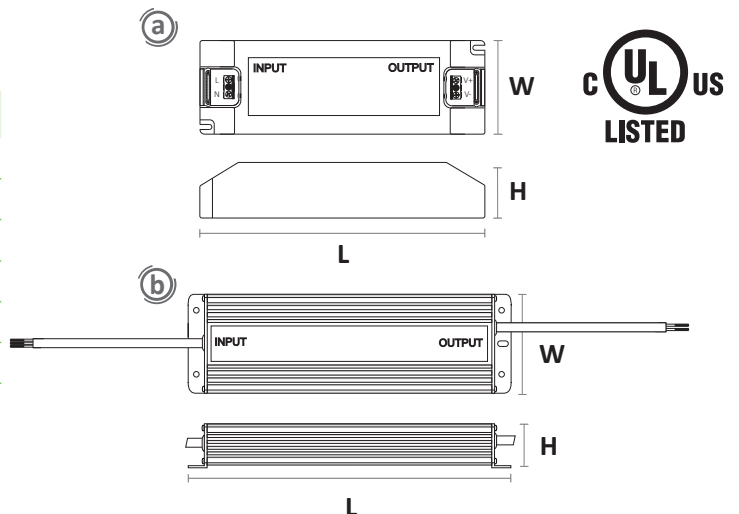

STREAMLITE™ DIFFUSED COB LINEAR LIGHT

SPECIFICATION SHEET

COMPATIBLE PRODUCTS

The following Listed LED Drivers are recommended for compatibility and to meet NEC code when installed according to specifications. For additional LED Driver options see Diode LED's product page at: <https://www.diodeled.com/products/led-power-supplies.html>

OMNIDRIVE® 2 ELECTRONIC DIMMABLE LED DRIVER

OMNIDRIVE 2 features a zero minimum load and 100-5% dimming range. Compatible with Forward Phase and Reverse Phase Dimmers. Please see Diode LED's Compatibility List at: <https://www.diodeled.com/custom/download/productFile/filename/DI-OD2-Compatibility%20List.pdf/>

[SPEC SHEET](#)

DI	OD2	Voltage & Power Output 24V24W
----	-----	---

SKU	L - LENGTH	W - WIDTH	H - HEIGHT
DI-OD2-24V24W	13.75 in.	3.00 in.	1.60 in.
DI-OD2-24V60W	13.75 in.	3.00 in.	1.60 in.
DI-OD2-24V96W	15.00 in.	3.10 in.	2.40 in.
DI-OD2-24V120W	15.00 in.	3.10 in.	2.40 in.
DI-OD2-24V200W	16.10 in.	3.40 in.	2.40 in.

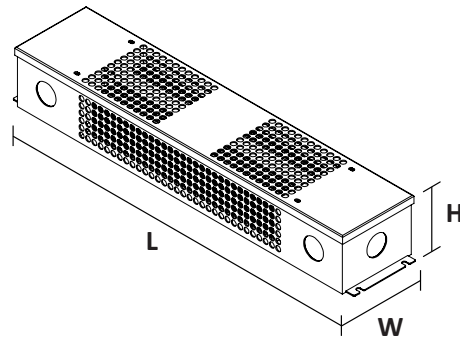

LUTRON OPTIONS

LUTRON® Hi-lume 1% LED DIMMABLE DRIVER

Hi-lume 1% LED Driver has a minimum load of 5W and dims from 100-1%.

DI-DM	Voltage & Power Output 24V40W	3-Wire or 2-Wire Dimmers L3D
-------	---	--

SKU	L - LENGTH	W - WIDTH	H - HEIGHT
DI-DM-24V40W-L3D	4.89 in.	4.00 in.	2.62 in.
DI-DM-24V40W-LTE			

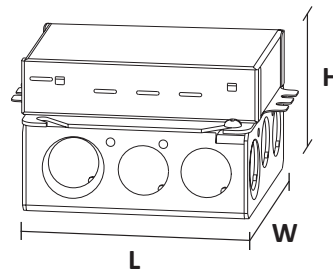

[L3D SPEC SHEET](#)

[LTE SPEC SHEET](#)



LUTRON® Hi-lume Premier 0.1% LED DIMMABLE DRIVER

Hi-Lume Premier 0.1% LED Driver has a minimum load of 5W and dims from 100-0.1%.

DI-DM	Voltage & Power Output 24V96W	L3D
-------	---	------------

SKU	L - LENGTH	W - WIDTH	H - HEIGHT
DI-DM-24V96W-L3D	5.50 in.	2.20 in.	10.50 in.

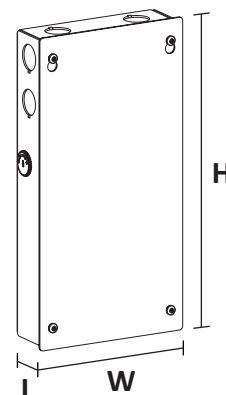

[SPEC SHEET](#)



STREAMLITE™ DIFFUSED COB LINEAR LIGHT

SPECIFICATION SHEET

ACCESSORIES

CHROMAPATH® BUILDER CHANNEL COVERS (individual*) - SLIM / SQUARE / 45° / DUO

SKU	FINISH	FORM FACTOR	BUNDLES	DESCRIPTION
DI-CPCHC-FR48**	Frosted	Frosted Cover (48 in.)	Single or 10 Pack	Protects LED tape light and slightly softens light. Note: there is an average warm shift in Kelvin of 35K and an average 28% decrease in delivered lumens.
DI-CPCHC-FR96**	Frosted	Frosted Cover (96 in.)		
DI-CPCHC-CL48**	Clear	Clear Cover (48 in.)		
DI-CPCHC-CL96**	Clear	Clear Cover (96 in.)		

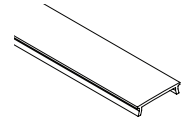

*not for use with Fully Loaded Channels

** - SKUs listed above are for Single covers. Add a -10 for a 10 pack bundle.

CHROMAPATH® BUILDER CHANNEL MOUNTING OPTIONS - SLIM

SKU	FINISH	FORM FACTOR	BUNDLES	DESCRIPTION
DI-1633	N/A	SLIM Mounting Tape (TP)	4 ft. x 0.75 in.	3M® high-bond double-sided adhesive tape designed to install the CHROMAPATH SLIM on a flat, indoor surface.
DI-1634			12 ft. x 0.75 in.	
DI-CPCH-UC-BA DI-CPCH-UC-WH DI-CPCH-UC-BL	AL WH BL	SLIM Mounting U-Clips	Pack of 2 clips / 4 screws	Secure SLIM Channel to flat surface with this pressure-fit clip. Also compatible when installed with PREMIUM DIFFUSION cover. Adds 0.12in. height to channel.

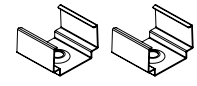

CHROMAPATH® BUILDER CHANNEL MOUNTING OPTIONS - SQUARE / 45° / DUO

SKU	FINISH	FORM FACTOR	BUNDLES	DESCRIPTION
DI-CPMC2-SCR4 DI-1630-20	Steel	Mounting Clips (MTC)	Pack of 2 clips / 4 screws	Secure CHROMAPATH to flat surface with this pressure-fit clip. Adds 0.12in. height to channel.
			Pack of 20 clips / 40 screws	
DI-1912	Steel	Vertical Mounting Brackets (VERT)	Pack of 2	Used to install CHROMAPATH in a vertical orientation and includes an Allen key and allen screws for securing to a vertical surface. Note: Mounting Clips, or Rotating Mounting Clips required for installation of Vertical Mounting Brackets.
DI-CPCH-HNG	Steel	Hanging Hardware Kit (HNG)	Pack of 2 hanging mounts / 2 Wire restrainers / 4 screws	Transform your CHROMAPATH Channel into a pendent fixture with CHROMAPATH Hanging Hardware Kit.
DI-CPCH-RC-BA DI-CPCH-RC-WH DI-CPCH-RC-BL	AL WH BL	Rotating Mounting Clips (RTC)	Pack of 2 clips / 4 screws	Secure CHROMAPATH to flat surface and adjust to desired angle with this pressure-fit clip. Adds 0.74in. height to channel.

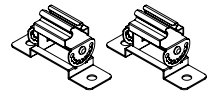
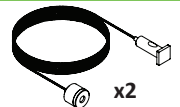
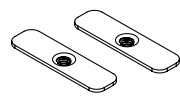
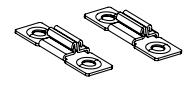

STREAMLITE™ DIFFUSED COB LINEAR LIGHT

SPECIFICATION SHEET

SPECIFICATIONS

- Input: 24VDC Constant Voltage
- LED Chip Beam Angle: 120°
- Luminous Efficacy³ (lm/w): 87~97
- Mounting: 3M mounting tape on back of tape.
- Connections: 36" female DC lead, and 36" bare lead: 22/2 AWG
- Ambient Temp⁴: -4 - 122°F (-20 ~ 50°C)
- Operating Temp⁵: -4 - 176°F (-20 ~ 80°C)

SPECIFYING?

Note: The compatible products listed in this Specification Sheet are provided for reference only. For complete specifications of compatible products, click on the [SPEC SHEET](#) links provided.

COMPLIANCE & REGULATORY APPROVALS

Safety

- UL Listed 2108 Flexible Lighting Systems. Certified for United States and Canada. File # E469769.

Performance

- Photometric & Colorimetry data measured in accordance to IES LM-79-08, in Elemental LED's Innovation Lab.

STREAMLITE™ DIFFUSED COB LINEAR LIGHT

SPECIFICATION SHEET

SAFETY / WARNINGS / DISCLOSURES

1. Install in accordance with national and local electrical code regulations.
2. This product is intended to be installed and serviced by a qualified, licensed electrician.
3. Only install with a listed Class 2 DC Constant Voltage LED Driver.
4. Not for use in or on walls of pools, fountains, or other partially or fully submersed locations.
5. Do not modify or disassemble product beyond instructions or this warranty will be void.
6. Actual color may vary from what is pictured above and on other print materials due to the limitations of photographic processes.
7. We reserve the right to modify and improve the design of our fixtures without prior notice. We cannot guarantee to match existing installed fixtures for subsequent orders or replacements in regards to product appearance, CCT, or lumen output.

WARRANTY

Limited Warranty

This product has a five (5) year limited warranty from the date of shipment. This warranty does not include the additional accessories referenced in this specification sheet. Complete warranty details for fixtures and additional accessories are available at www.diodeled.com/limited-warranty/ within the Policies section. For warranty related questions please contact product support.

Consumer's Acknowledgment

Elemental LED, Inc. stands behind its products when they are used properly and according to our specifications. By purchasing our products, the purchaser agrees and acknowledges that lighting design, configuration and installation is a complex process, wherein seemingly minor factors or changes in layout and infield adjustments can have a significant impact on an entire system. Choosing the correct components is essential. Elemental LED is able to work with the original purchaser to make an appropriate product selection to the extent of the limited information that the customer can provide, but it is virtually impossible for Elemental LED to design a system that foresees every unknown factor. For this reason, this Warranty does not cover problems caused by improper design, configuration or installation issues. Any statement from an Elemental LED employee or agent regarding a customer's bill of goods and/or purchase order is NOT an acknowledgment that the products purchased are designed and configured correctly. The purchaser agrees and acknowledges that it is the customer's responsibility to adhere strictly to all information contained in the Product Specification Sheets.

There is often more than one way to design, configure and layout an LED lighting application properly to achieve the same lighting effect. Elemental LED strongly recommends that licensed professionals be used in the design and installation of lighting systems that include Elemental LED products. The specifications include important information that a designer and installer should carefully review and strictly follow. Qualified designers and certified and/or licensed installers, with access to the final installation environment, customer goals, and Elemental LED product specifications can make the requisite decisions appropriate for a successful finished lighting application.



© 2020 Elemental LED, Inc. All rights reserved.
Specifications are subject to change without notice.

Toll Free: 877.817.6028 | Fax: 415.592.1596 | www.DiodeLED.com | info@DiodeLED.com