

Linear

Groove IN (HCRI) Fixture Guide

KKDÖ

Indoor | Recessed | Low output up to 32lm/m (10lm/ft)



Key applications

- ✓ Cabinet/Furniture
- ✓ Interior
- ✓ Orientation lighting

Key features

- ✓ Custom lengths
- ✓ Decorative
- ✓ Diffusion: Homogenous
- ✓ Direct view
- ✓ Form factor: Small
- ✓ IP40
- ✓ IP65
- ✓ Output low
- ✓ Thin light line

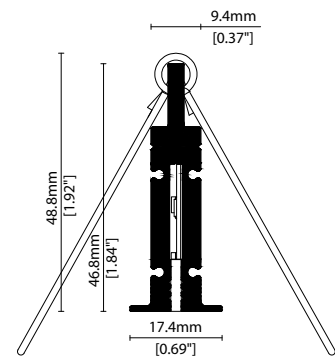

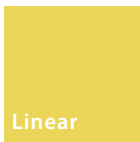

Groove IN (HCRI)

Specification sheet



Dimension	H46.8/W17.4/L115-1015mm (H1.84/W0.69/L4.53-39.96in) (Excluding spring clips)
PCB increment	100mm increment/1000mm max (3.94in increment/39.37in max)
Chip	s-line Toyoda Gosei
Beam angle	110° (Diffused Cover)
Colours	s-line 2700K/3000K/4000K
Bin/Step	s-line 3-step MacAdam ellipse
CRI	≥ 90
Lifetime	30,000 hours @ 25°C (30,000 hours @ 77°F)
Operating temp	T _a = -25 to 50°C (T _c max = 65°C) T _a = -13 to 122°F (T _c max = 149°F)
IP rating	IP40/IP65
Finish	Silver anodised
Cover/lens	Diffused
Mounting	Recessed mounting via spring clips
Power feed	Hardwire tails
Control	0-10V/1-10V/DMX/DALI



LED Grading Key

Exclusive Grade

S **s-line***
3-step CCT range

*KKDC tuned
CCT range

PERFORMANCE DATA @ 3000K

Power consumption	Supply voltage	Supply current
7.7 W/m (2.34W/ft)	24V DC	0.31A/m (0.95A/ft)

Colour Rendering Index (CRI)

	R1	R2	R3	R4	R5	R6	R7	R8	R9	R10	R11	R12	R13	R14
s-line	96	96	97	96	97	91	92	88	74	96	90	82	95	97

	Diffused Cover	CRI	R9	Rf	Rg
s-line	32lm/m (10lm/ft) 4lm/W	94	74	-	-

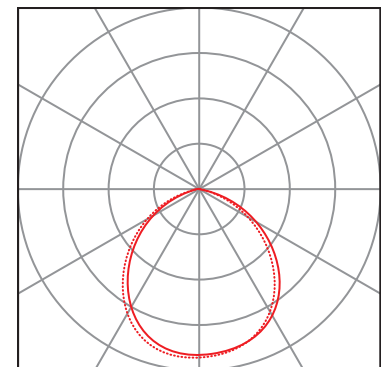
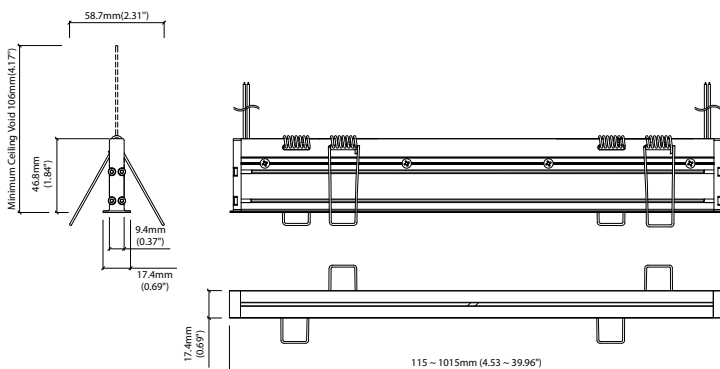

— C0 / C180 cd / 1000 lm - - - C90 / C270

Data derived from independent UKAS / IESNA LM-79-08 accredited testing of production samples.

Groove IN (HCRI) Code Table



FIXTURE

Model	Finish	Cover	Grade*	LED	Colour (CCT)	Length Availability**	IP	Cable Length	Power Feed***	Input										
Groove IN	GN	Silver Anodised	SA	Diffused	C	s s	103	2700K	27	m	115-1015mm 100mm increments	IP40	40	300mm (11.81in)	0300	Single no sheath tail	S00X	DC 24V	g	
								3000K	30				IP65							65
								4000K	40											
(Specify length code OR total run length)																				

* Refer to **LED Grading Key** on **Specification sheet** page** Refer to **Length Availability List** or enter total run length instead of length code*** Refer to **Power Feed Options** on **Options** pages

Code Example:

GN	-	SA	-	C	-	s	-	103	-	30	-	m	-	500	-	40	-	0300	-	D00X	-	g
Groove IN		Silver Anodised		Diffused		s		103		3000K		515mm		IP40		300mm (11.81in)		Double no sheath tail		DC 24V		

ACCESSORIES

Connection Accessories

KKCN-01	2 PIN male & female 50mm (1.97in) pair
KKCN-03	2 PIN male & female 300mm (11.81in) pair
KKCN-06	2 PIN 300mm (11.81in) extension lead

PSU/Driver

0-10V/1-10V/Dali/DMX

* Refer to **Driver/PSU Options** page for details or provide requirement and KKDC to offer the suitable option* Refer to **Power feed** on **Accessories** pages

LED ENGINE VARIANTS (LED STRIP TYPE)

Luminaire	Output	LED	Lumen/m	Lumen/ft	W/m	W/ft	Spec Doc	Length	Increment
Groove IN (HCRI)	Low	103	32	10	7.7	2.34	Groove IN (HCRI)	115-1015mm (4.53-39.96in)	100mm (3.94in)
Groove IN RGB		101	Red 2 Green 10 Blue 3 RGB 15	Red 0.6 Green 3 Blue 1 RGB 5	21.6	6.58	Groove IN RGB	115-1015mm (4.53-39.96in)	100mm (3.94in)

* Performance data: s-line, diffused cover, 3000K

Groove IN (HCRI)

Length Availability List



Length Code		Fixture Length ¹		LED Strip ²		End Cap Dimension ³		Wattage (W)	Output (lm)	
Metric	Imperial(US)	Metric	Imperial(US)	Metric	Imperial(US)	Metric	Imperial(US)		3000K (Test Data)	Range Data
m0115	i0005	115mm	4.53in	100mm	3.94in	7mm	0.28in	0.77	3.1	2.5-3.2
m0215	i0008	215mm	8.46in	200mm	7.87in	7mm	0.28in	1.54	6.2	4.9-6.4
m0315	i0012	315mm	12.40in	300mm	11.81in	7mm	0.28in	2.31	9.2	7.4-9.6
m0415	i0016	415mm	16.34in	400mm	15.75in	7mm	0.28in	3.08	12.3	9.9-12.8
m0515	i0020	515mm	20.28in	500mm	19.69in	7mm	0.28in	3.85	15.4	12.3-16.0
m0615	i0024	615mm	24.21in	600mm	23.62in	7mm	0.28in	4.62	18.5	14.8-19.2
m0715	i0028	715mm	28.15in	700mm	27.56in	7mm	0.28in	5.39	21.6	17.2-22.4
m0815	i0032	815mm	32.09in	800mm	31.50in	7mm	0.28in	6.16	24.6	19.7-25.6
m0915	i0036	915mm	36.02in	900mm	35.43in	7mm	0.28in	6.93	27.7	22.2-28.8
m1015	i0040	1015mm	39.96in	1000mm	39.37in	7mm	0.28in	7.70	30.8	24.6-32.0

¹ Actual total overall length of light fixture (LED strip + end caps + void/wire hole)

² Actual length of PCB strip

³ Actual length of 2x end caps

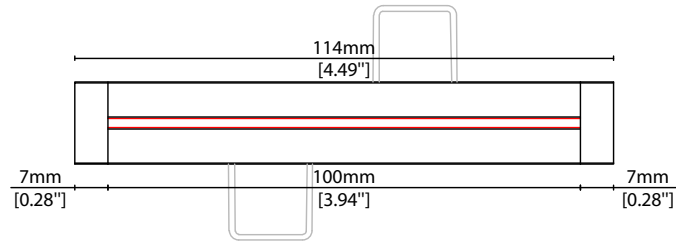

POWER FEED OPTIONS

* Options are an integral part of the fixture ordering codes. Please refer to **Code Table** pages.

0300 S00X 300mm (11.81") Single no sheath tail

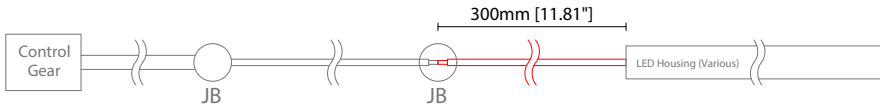

0300 D00X 300mm (11.81") Double no sheath tail

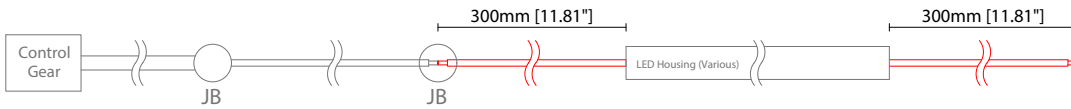

Key

Control Gear	Power supply, sub-controllers & control systems
JB	Junction box / cable connection

POWER FEED

Note: Accessories are to be ordered separately with corresponding code shown below.

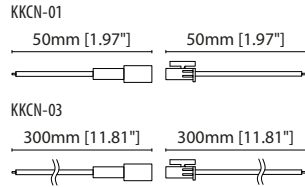
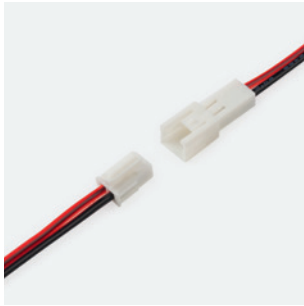

KKCN-01 50mm (1.97in) pair
KKCN-03 300mm (11.81in) pair
 2 PIN male + female connector set

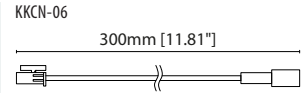

KKCN-06
 2 PIN 300mm (11.81in) extension lead

KKDC CONTROL



IP20
 Black plastic housing
 L164/W64/H34mm
 (L6.46/W2.52/H1.34in)

KKDM-05 1-10V
 visDIM dimmable sub-controller



IP20
 Black plastic housing
 L164/W64/H34mm
 (L6.46/W2.52/H1.34in)

KKSC-03A DMX (screw terminal)
 visDIM dimmable sub-controller



IP20
 Black plastic housing
 L164/W64/H34mm
 (L6.46/W2.52/H1.34in)

KKSC-03B DMX (RJ45)
 visDIM dimmable sub-controller



IP20
 Plastic housing
 L170/W59/H29mm
 (L6.69/W2.32/H1.14in)

KKDL-02 DALI
 visDIM dimmable sub-controller
 (4 x 8A max @ 12-36V)



Groove IN (HCRI) Accessories



KKDC CONTROL (CONTINUED)



IP20
Plastic housing
L166/W53.4/H23mm
(L6.54/W2.10/H0.91in)

KKDL-03 DALI

visDIM dimmable sub-controller
(4 x 5A max @ 12-36V)

AVAILABLE PSU OPTIONS

Control Mode	PSU (Order Code)	Input Voltage AC	Output Voltage DC	Rated Output Current	Rated Power	Dim %	IP Rating
Switched	CEN-60-24	90-295V	24V	2.5A	60W	-	IP67
	HLG-60H-24	90-305V	24V	2.5A	60W	-	IP67
	HLG-100H-24	90-305V	24V	4.0A	100W	-	IP67
	HLG-150H-24	90-305V	24V	6.3A	150W	-	IP67
	HLG-240H-24	90-305V	24V	10A	240W	-	IP67
0-10V (1-10V)	PWM-40-24	90-305V	24V	1.67A	40W	100-0.15 (100-10)	IP67
	PWM-60-24	90-305V	24V	2.5A	60W	100-0.15 (100-10)	IP67
	PWM-90-24	90-305V	24V	3.67A	90W	100-0.15 (100-10)	IP67
	PWM-120-24	90-305V	24V	5.0A	120W	100-0.15 (100-10)	IP67
DALI	LIN100A1	120-277V	24V	1A per channel	100W	100-0.1	IP66/IP40
DMX RGB	LIN100A1	120-277V	24V	1.33A per channel	100W	100-0.1	IP66/IP40
DMX RGBW	LIN100A1	120-277A	24V	1A per channel	100W	100-0.1	IP66/IP40

Flicker Free Options - Combination of PSU+ sub-controller

Control Mode	PSU (Order Code)	Sub-controller (Order Code)	Input Voltage AC	Output Voltage DC	Rated Output Current	Rated Power	Dim %	IP Rating PSU/ Sub-controller
0-10V or 1-10V	CEN-60-24	KKDM-05	90-295V	24V	2.5A	60W	100-0.9	IP67/IP20
	HLG-60H-24	KKDM-05	90-295V	24V	2.5A	60W	100-0.9	IP67/IP20
	HLG-100H-24	KKDM-05	90-295V	24V	4.0A	100W	100-0.9	IP67/IP20
	HLG-150H-24	KKDM-05	90-295V	24V	6.3A	150W	100-0.9	IP67/IP20
	HLG-240H-24	KKDM-05	90-295V	24V	10.0A	240W	100-0.9	IP67/IP20
DALI	CEN-60-24	KKDL-02/03	90-295V	24V	2.5A	60W	100-0.1	IP67/IP20
	HLG-60H-24	KKDL-02/03	90-305V	24V	2.5A	60W	100-0.1	IP67/IP20
	HLG-100H-24	KKDL-02/03	90-305V	24V	4.0A	100W	100-0.1	IP67/IP20
	HLG-150H-24	KKDL-02/03	90-305V	24V	6.3A	150W	100-0.1	IP67/IP20
	HLG-240H-24	KKDL-02/03	90-305V	24V	10.0A	240W	100-0.1	IP67/IP20
DMX RGB	CEN-60-24	KKSC-03	90-295V	24V	2.5A	60W	100-0.9	IP67/IP20
	HLG-60H-24	KKSC-03	90-305V	24V	2.5A	60W	100-0.9	IP67/IP20
	HLG-100H-24	KKSC-03	90-305V	24V	4A	100W	100-0.9	IP67/IP20
	HLG-150H-24	KKSC-03	90-305V	24V	6.3A	150W	100-0.9	IP67/IP20
	HLG-240H-24	KKSC-03	90-305V	24V	10.0A	240W	100-0.9	IP67/IP20

¹ The items shown above cover the most frequently used specification but does not exhaust the possible options

² PSU and/or driver can be chosen from the table, or KKDC may recommend the best option upon receipt of the controls requirement and installation environment

³ Electrical shop drawing will include detailed information of PSU and relevant control drivers

⁴ Cut sheets are available on the controls section of www.kkdc.lighting or upon request